



CITEL

Type 1+2+3 AC surge protector - Single phase

DS132VGS-120



- ▶ Discover our latest innovation : the [DAC1-13VGS-11-150](#)
- ▶ Type 1 + 2 + 3 AC surge protector
- ▶ In : 20 kA
- ▶ Iimp total : 25 kA on 10/350µs impulse
- ▶ Pluggable module
- ▶ Optimized to TOV
- ▶ Remote signaling
- ▶ EN 61643-11, IEC 61643-11 and UL1449 ed.5 compliance

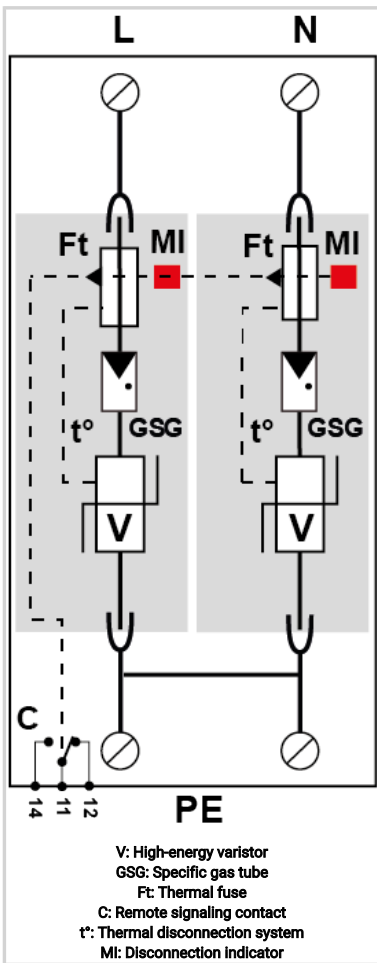

Electrical Characteristics		
SPD type	IEC	1+2+3
Network		120/208 V
AC system		TN
Nominal line voltage	Un	120 Vac
Max. AC operating voltage	Uc	150 Vac
Temporary Over Voltage (TOV) Characteristics - 5 sec. Without disconnection	UT	180 Vac withstand
Temporary Over Voltage (TOV) Characteristics - 120 mn Without disconnection or with safety disconnection	UT	230 Vac withstand
Residual Current	Ipe	None
Leakage current to Ground		
Follow current	If	None
Nominal discharge current 15 x 8/20 µs impulses	In	20 kA
Max. discharge current max. withstand @ 8/20 µs by pole	Imax	50 kA
Impulse current by pole max. withstand 10/350µs by pole	Iimp	12.5 kA
Total lightning current max. total withstand @ 10/350µs	Itotal	25 kA
Withstand on Combination waveform IEC 61643-11 Class III test: 1.2/50µs - 8/20µs	Uoc	20 kV
Withstand on overvoltages IEEE C62.41.1		20 kV
Specific energy by pole max. withstand 10/350 µs	W/R	40 kJ/ohm
Connection mode(s)		L/PE and N/PE
Protection mode(s)		Common mode
Residual voltage @ In (8/20 µs)	Up-in	0.4 kV
Protection level L/PE @ In (8/20µs)	Up L/PE	1.25 kV
Admissible short-circuit current	Iscsr	25 000 A
Mechanical Characteristics		
Technology		VG Technology (MOV+GSG)
SPD configuration		Single phase
Connection to Network		By screw terminals: 2.5-25mm² / by bus
Format		Plug-in modular box
Mounting		Symmetrical rail 35 mm (EN 60715)
Housing material		Thermoplastic UL94 V-0
Operating temperature	Tu	-40/+85°C
Protection rating		IP20
Failsafe mode		Disconnection from AC network
Disconnection indicator		1 mechanical indicator by pole
Spare module(s)		DSM130VG-120
Remote signaling of disconnection		Output on changeover contact
Dimensions		See diagram
Disconnectors		
Thermal disconnector		Internal
Installation ground fault breaker		Type 'S' or delayed
Back-up protection device		Fuses Type gG - 125 A
Standards		
Standards compliance		IEC 61643-11 / EN 61643-11 / UL1449 ed.5
Part number		
571682		

