



CITEL

1-pair Data surge protector unit

B180-12D3



- Compact 1-pair surge protection unit
- 12 V
- Removable protection circuit
- Wall mounting and screw connection
- UL497 A&B

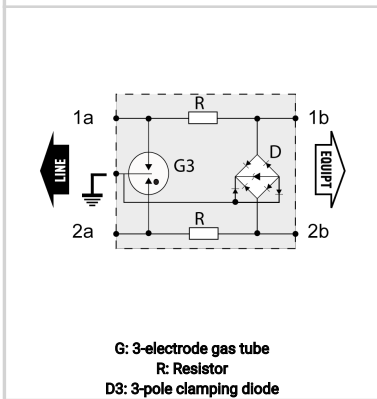
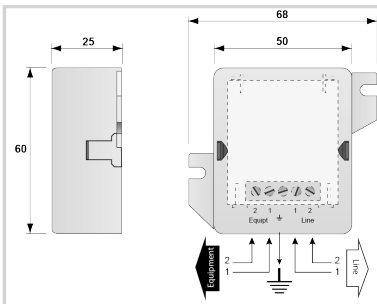

Electrical Characteristics

Network		RS232, RS485
Nominal line voltage	Un	12 Vdc
Max. DC operating voltage	Uc	15 Vdc
Max. frequency	f max.	20 MHz
Insertion loss		< 1 dB
Max. discharge current max. withstand @ 8/20 μs by pole	Imax	20 kA
Nominal Discharge Current C2 (1.2/50μs / 8/20μs), 10 applications, X-X (Line/Line)	In	5 kA
Protection Level C3 (10/1000μs), 300 applications@10 A, Y-Y (Line/Line)	Up	30 V
Impulse current 2 x 10/350μs Test - D1 Category	limp	2.5 kA
Max. Load current	IL	300 mA
Line resistance		< 4.7 Ohm

Mechanical Characteristics

Technology		GDT + R + Diode
SPD configuration		1 pair
Connection to Network		By screw terminal: cross section 0.4-1.5mm ²
Format		Wall mounting box
Mounting		Wall mounting by screws (not supplied)
Housing material		Thermoplastic UL94 V-0
Operating temperature	Tu	-40/+85°C
Protection rating		IP20
Failsafe mode		Short-circuit - transmission cut-off - fault mode 2
Spare module(s)		S180-12D3
Dimensions		See diagram

Standards

Standards compliance		IEC 61643-21 / EN 61643-21 / UL497B
Certification		UL listed
Environmental standards		EU RoHS

Part number

510202

