



Coaxial surge protector DC-3.5 GHz

CITEL

P8AX15-N/FF



- RF coaxial surge protector
- 3.5 GHz
- Connectors: N
- Low insertion loss
- Removable GDT
- DC-pass
- Bi-directional protection

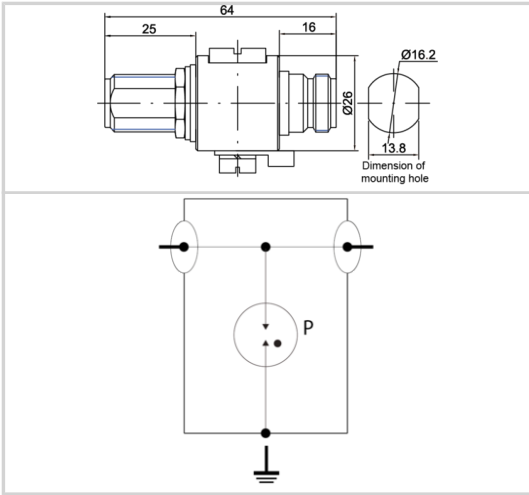

Electrical Characteristics		
Max. DC operating voltage	Uc	120 Vdc
Frequency range	f	DC-3.5 GHz
Insertion loss		< 0.2 dB
Return loss		> 20 dB
Impedance		50 ohms
VSWR		<1.2:1
Max. load current @25°C	IL	10 A
Residual Current Leakage current to Ground	Ipe	None
Max. discharge current max. withstand @ 8/20 µs by pole	I _{max}	20 kA
Protection mode(s)		Common mode
Protection level @1kV/µs (C3)	Up	< 700 V
Impulse current 2 x 10/350µs Test - D1 Category	I _{imp}	1 kA
Nominal discharge current C2 Category	I _n	5 kA
Max Power		70 W
Typical let through energy (50 ohms) input 4kV 1.2/50µs - 2kA 8/20µs		320 µJ
DC Pass		Yes
Insulation resistance	IR	≥10 GOhms
Mechanical Characteristics		
Technology		Gas discharge tube
Connection to Network		Connector N Female/Female
Mounting		Feedthrough
Housing material		Brass/Surface plating: Cu Zn Sn
Operating temperature	Tu	-40/+85°C
Protection rating		IP65
Failsafe mode		Short-circuit
Disconnection indicator		Transmission interrupt
Spare module(s)		BBHF-150V
Dimensions		See diagram
Contacts		Bronze/Surface Au-Ag
Standards		
Standards compliance		IEC 61643-21 / EN 61643-21 / UL497E
RohS compliance		Yes
Part number		
60012		

