



Type 1+2 AC surge protector - 3-phase

CITEL

DS133VGS-230



➤ Discover our latest innovation : the [DAC1-13VGS-30-275](#)

➤ Type 1 + 2 + 3 AC surge protector

➤ In : 20 kA

➤ Iimp total : 37.5 kA on 10/350µs impulse

➤ Pluggable module

➤ Optimized to TOV

➤ Remote signaling

➤ EN 61643-11, IEC 61643-11 and UL1449 ed.5 compliance

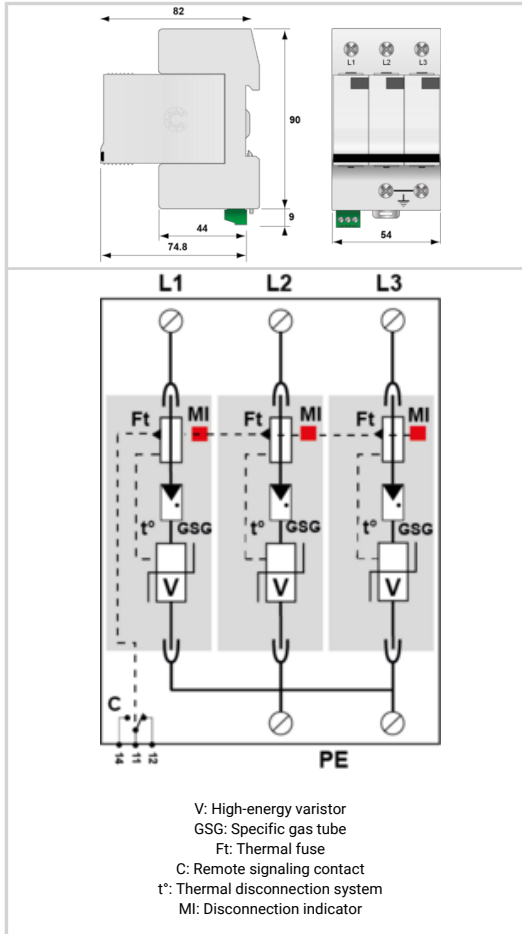

Electrical Characteristics	
SPD type	1+2+3
Network	230/400 V 3-phase
AC system	TNC
Nominal line voltage	Un 230 Vac
Max. AC operating voltage	Uc 275 Vac
Temporary Over Voltage (TOV) Characteristics - 5 sec. Without disconnection	UT 180 Vac withstand
Temporary Over Voltage (TOV) Characteristics - 120 mn Without disconnection or with safety disconnection	UT 230 Vac withstand
Residual Current Leakage current to Ground	Ipe None
Follow current	If None
Nominal discharge current 15 x 8/20 µs impulses	In 20 kA
Max. discharge current max. withstand @ 8/20 µs by pole	Imax 50 kA
Impulse current by pole max. withstand 10/350µs by pole	Iimp 12.5 kA
Total lightning current max. total withstand @ 10/350µs	Itotal 37.5 kA
Withstand on Combination waveform IEC 61643-11 Class III test: 1.2/50µs - 8/20µs	Uoc 20 kV
Withstand on overvoltages IEEE C62.41.1	20 kV
Specific energy by pole max. withstand 10/350 µs	W/R 40 kJ/ohm
Connection mode(s)	L/PE
Protection mode(s)	Common mode
Residual voltage @ In (8/20 µs)	Up-in 0.6 kV
Protection level L/PE @ In (8/20µs)	Up L/PE 1.25 kV
Admissible short-circuit current	Iscrr 25 000 A
Mechanical Characteristics	
Technology	VG Technology (MOV+GSG)
SPD configuration	3-phase+Neutral
Connection to Network	By screw terminals: 2.5-25mm² / by bus
Format	Plug-in modular box
Mounting	Symmetrical rail 35 mm (EN 60715)
Housing material	Thermoplastic UL94 V-0
Operating temperature	Tu -40/+85°C
Protection rating	IP20
Failsafe mode	Disconnection from AC network
Disconnection indicator	1 mechanical indicator by pole
Spare module(s)	DSM130VG-230
Remote signaling of disconnection	Output on changeover contact
Dimensions	See diagram
Disconnectors	
Thermal disconnector	Internal
Installation ground fault breaker	Type 'S' or delayed
Back-up protection device	Fuses Type gG - 125 A
Standards	
Standards compliance	IEC 61643-11 / EN 61643-11 / UL1449 ed.5
Certification	UL Recognized
Part number	
571583	

